

MATHY BYBOLS
THE BELGIAN CREATIVE FACTORY



ORIGINAL DESIGNS
FOR YOUR ORIGINAL KIDS



STABLE COLLECTION	06
DISCOVERY	08
ASYMETRY	12
CABANES TREEHOUSE	18
CABANE STAR STAR TREEHOUSE	24
CARAVANE CARAVAN	25
TENTE TENT	26
ROULOTTE CARRIAGE	28
WAGON	29
MADAVIN	30
MADAKET	32
DOMINIQUE	34
FUSION	40
ARBRES TREES	42
BASILE	44
VESSEL	45
COULEURS COLORS	46

SAVOIR-FAIRE CRÉATIF CREATIVE KNOW-HOW SINCE 1987

Philosophie

L'enfance est un formidable moment d'épanouissement. Nous savons que vos enfants passent presque la moitié de leur vie dans leur chambre à coucher. Et que ces chambres à dormir sont également des chambres à jouer, à apprendre, à rêver... à vivre! Voilà pourquoi, depuis la création de notre usine, nous investissons, sans compter, dans la création de ces lieux exclusifs de petits et grands bonheurs au quotidien.

Chaque enfant est singulier

Assez atypique en son genre, Mathy by Bols est une fabrique d'ameublements qui a su résoudre la difficile équation de pouvoir produire beaucoup, avec des délais de fabrication courts et garantis, tout en préservant une véritable qualité de meuble d'artisan. Le catalogue de Mathy by Bols est extrêmement varié, et déclinable en de nombreuses gammes de couleurs. C'est parce que chaque famille et chaque enfant sont uniques que nous souhaitons offrir le maximum de flexibilité dans vos choix.

Esprit de corps

Notre premier investissement se situe dans le capital humain de l'usine. Nous sommes convaincus qu'une parfaite organisation du travail doit se concevoir dans le respect des hommes qui donnent forme aux meubles qui feront le bonheur de vos enfants. Mathy by Bols emploie près de 40 personnes, dont beaucoup de jeunes, à qui nous transmettons le savoir-faire menuisier et l'enthousiasme de défendre fièrement des valeurs d'artisan passionné et responsable.

Philosophy

Childhood is a key time to blossom. We know that your children spend almost half their life in their bedroom. And that bedrooms are also places to play, learn, dream... live! This is why, since we established our factory, we have invested freely in creating these exclusive spaces for large and small daily delights.

Every child is an individual

Fairly unusual in its sector, Mathy by Bols is a furniture manufacturer that has been able to solve the difficult problem of producing a high volume, quickly and with short, guaranteed lead times, while also maintaining the quality of genuine craftsman-made furniture. The Mathy by Bols catalogue offers a wide variety of products in many different color ranges. Because each family and each child are unique, we want to offer you the widest possible choice.

Team spirit

Our first investment is in the human resource in our factory. We believe that work must be organized in a manner that respects the men who shape the furniture that will delight your children. Mathy by Bols employs almost 40 people, including many young people, to whom we are transferring our carpentry know-how and the enthusiasm to uphold the values of passionate, responsible craftsmanship.

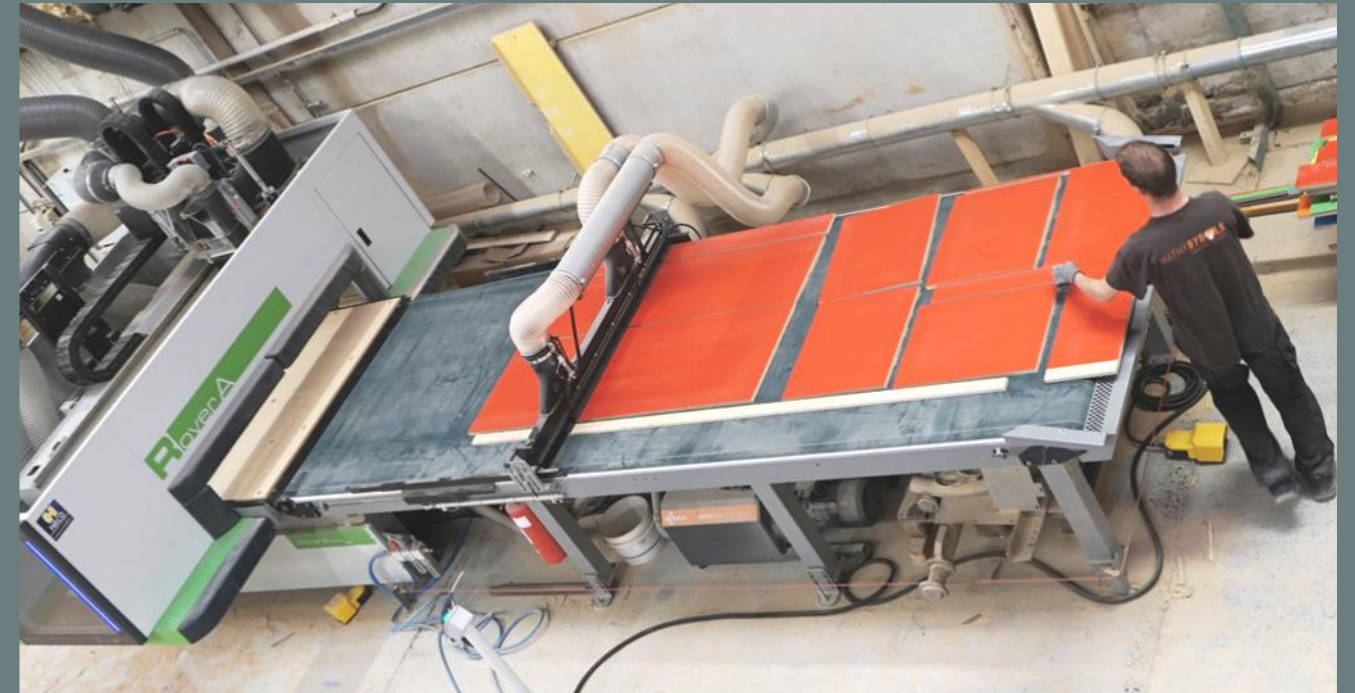

STABLE COLLECTION



MDF + SAPIN + PINE + 3D

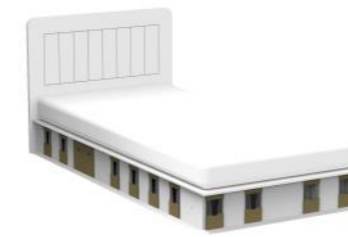

STA BED 90F 16S 4G

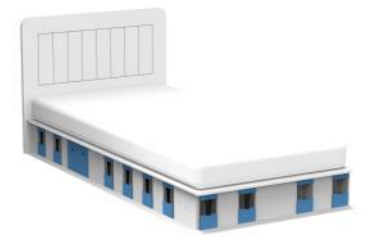
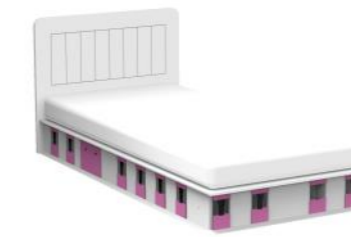

STA 195 6S 2G | STA 93 4G | STA 93 4S



STA 2S



STA 2SG

Pour les amoureux des chevaux et de la ferme !

Pour cette collection, Mathy by Bols a mis l'accent sur le jeu et l'imagination de l'enfant ! Grâce aux portes de boxes et de granges, l'enfant peut jouer autour du lit avec des chevaux et des animaux de la ferme. Il peut imaginer une histoire et créer sa propre ferme, s'appropriant ainsi ce nouveau terrain de jeu.

Des caissons avec des portes de boxes rappellent les écuries et créent des espaces dédiés pour les animaux. Les portes de grange s'ouvrent de chaque côté et offrent un espace plus grand pour ranger tracteurs, bottes de foin, ... Libre à l'enfant de laisser part à son imagination.

Notre lit et nos étagères Stable sont composés de caissons comprenant des boxes pour les chevaux et des granges pour la ferme. L'espace de repos devient également un espace de jeu. Cette collection inédite offre un vaste terrain de jeu à l'enfant qui pourra imaginer tout un nouveau monde pour ses animaux ! Le lit, près du sol, propose un certain esthétisme dans la chambre.

Le lit peut se placer en élément central de la pièce et créer un univers élégant et ludique pour l'enfant. La tête du lit, imitation planche de bois, reprend les codes des portes de boxes. Les caissons sont vendus séparément et peuvent s'utiliser comme table de chevet / table de jeu ou encore d'étagères de rangement dans la chambre ou dans d'autres pièces de la maison.

Les portes de boxes et de grange sont imprimées en 3D en Belgique, en 3 coloris : marron, rose et bleu.

For horse and farm lovers !

For this collection, Mathy by Bols has focused on children's play and imagination ! Thanks to the doors of boxes and barns, the child can play around the bed with horses and farm animals. He can imagine a story and create his own farm, making this new playground his own.

Boxes with box doors remind the stables and create dedicated spaces for animals. The barn doors open on each side and offer more space to store tractors, hay bales, etc. Children can let their imagination run free.

Our stable bed and shelves are composed of boxes including boxes for the horses and barns for the farm. The resting area also becomes a space for play and storage. This unique collection offers a vast playground for children who can imagine a whole new world for their animals and farm equipment! The bed, close to the floor, offers a certain aesthetic in the bedroom.

The bed can be placed as a central element of the room and create an elegant and playful universe for the child. The head of the bed, imitation wooden plank, uses the codes of box doors. The boxes are sold separately and can be used as a nightstand, game table or as storage shelves in the bedroom or in other rooms of the house. We have also provided a simplified version where the bed is placed along a wall.

The boxes and barn doors are 3D printed in Belgium and in 3 colors: brown, pink and blue.

DISCOVERY - MONTESSORI

BY CORALIE REVAUD

DISCO 1 BAL 90F SO | BASILE



DISCO 1 LIT 90F SO



DISCO 1 SUP 90F 2SO



Le lit Discovery s'inscrit dans la pédagogie active développée par Montessori.

Il permet à l'enfant de faire ses apprentissages lui-même en le laissant explorer son environnement. Ainsi, en sortant aisément, l'enfant peut aller et venir de manière autonome et découvrir le monde qui l'entoure. Par la suite, le lit Discovery s'adapte aux besoins de l'enfant comme à ceux de ses parents, de manière évolutive. Le lit Discovery accompagne la croissance de l'enfant. Il peut être élevé à une hauteur plus classique et accueillir un tiroir lit. Et quand la famille s'agrandit, le lit Discovery peut évoluer en lits superposés. Ce modèle original permet à l'enfant de partir à la découverte du monde tout en se créant le sien. Les éléments du design suggèrent le mouvement mais ils sont libres d'interprétation. Il peut aussi bien être associé à un moyen de locomotion qu'à l'étal du marchand ambulant ou du marchand de glace.

Tous les rêves sont permis...

Le lit Discovery est principalement constitué de pin massif auquel s'ajoutent des éléments en MDF certifié PEFC. Il est disponible en vernis naturel et 26 laques, à base d'eau.

The Discovery bed is part of Montessori's active pedagogy.

It enables the child to do his own learning by letting him explore his environment. By coming out easily, he can come and go autonomously and discover the world around him. The bed is adapted to child's and parents' needs, in an evolutionary way. The Discovery bed accompanies the growth of the child. Thereafter, it can be raised to a more conventional height and even accommodate with a drawer bed. And when the family gets bigger, the bed can evolve into bunk beds. This original model allows the child to discover the world while creating his own. The elements of the design suggest the movement but they are free of interpretation. It may as well be associated with a means of locomotion than the stall of the street vendor or an ice cream seller.

All dreams are allowed...

The bed is mainly composed of solid pine wood with MDF elements added. The woods are PEFC registered. It is available in natural varnish and 26 water based lacquers.

DISCOVERY - MONTESSORI

MDF + SAPIN + PINE



Disponible en largeur 120cm. Le tiroir = toujours 90cm - Available in width 120cm. The drawer = always 90cm



DISCO 1 LIT 90F SO



DISCO 1 LIT 90F SO
DISCO 1 KIT F INF



DISCO 1 LIT 120F SO
DISCO 1 KIT F INF

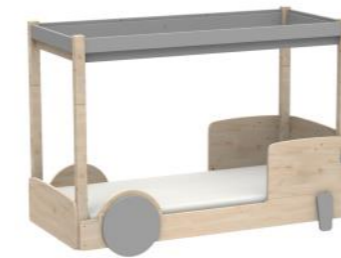

DISCO 1 BAL 90F SO



DISCO 1 BAL 90F SO
DISCO 1 KIT F INF



DISCO 1 BAL 120F SO
DISCO 1 KIT F INF

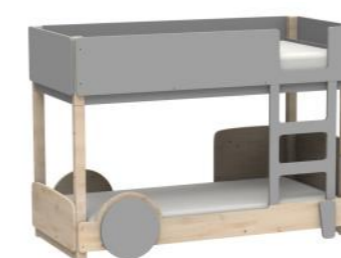
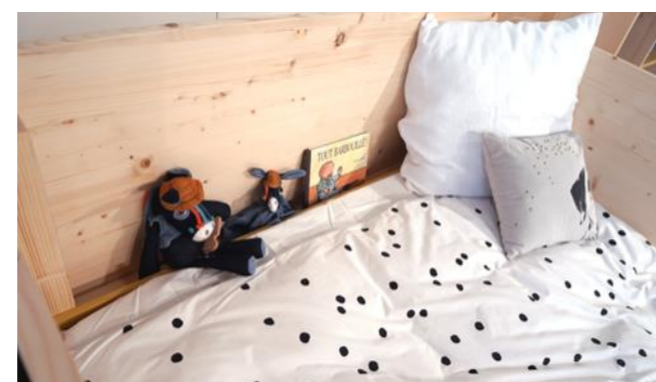

DISCO 1 SUP 90F SO



DISCO 1 SUP 90F SO
DISCO 1 KIT F INF



DISCO 1 SUP 120F SO
DISCO 1 KIT F INF



DISCO 1 KIT F INF



DISCO 1 KIT F LIT BAL



DISCO 1 KIT F LIT SUP



DISCO 1 KIT F BAL SUP

ASYMETRY - MONTESSORI

BY MANON ALVES

ASY W20 B1 T1 D2 | ASY L10 | ASY DS10 | ASY B1

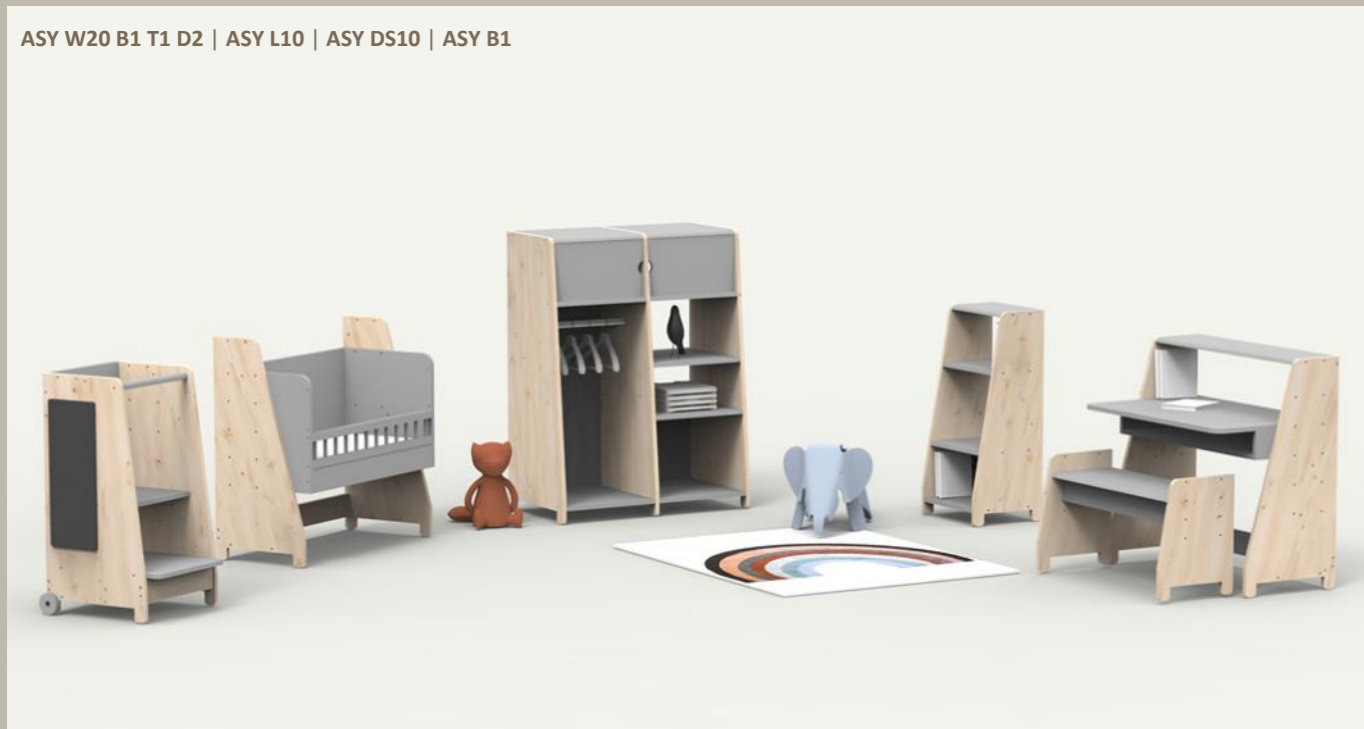

CRÉEZ VOTRE COMBINAISON ASYMETRY
CREATE YOUR OWN ASYMETRY COMBINAISON

ASY DS20 L30 | ASY B1 2x



ASY DS10 L20 | ASY B1 | ASY W24 B1 T1 D2



ASY L10

ASY L11

ASY L20

ASY DS10

ASY DS10 L10

ASY B1

ASY W10

ASY W20 B1 T1 D2

ASY W22 B1 T1 D2

Asymetry est une gamme de mobilier de rangement aux lignes douces et asymétriques.

Asymetry is a range of storage furniture with soft and asymmetrical lines.

Basée sur la pédagogie active développée par Maria Montessori, Asymetry permet de développer l'autonomie et la motricité de l'enfant dès le plus jeune âge en proposant du mobilier évolutif adapté et à hauteur de l'enfant. Cette collection se compose d'une penderie, d'une étagère et d'un bureau. L'enfant peut accéder à ses affaires et prendre des décisions par lui-même en toute autonomie.

Based on the active pedagogy developed by Maria Montessori, Asymetry enables to develop the autonomy and motor skills of the child from an early age by offering scalable furniture adapted to the height of the child. This collection is composed of a wardrobe, a shelf and a desk. The child can easily access to his belongings, choose by himself and make his own decisions independently.

La gamme est pensée afin d'optimiser et de rationaliser la production grâce à ses formes standardisées et son caractère évolutif qui permettent d'inscrire la collection dans une démarche éco-design. Asymetry évolue et s'adapte aux nouveaux besoins de l'enfant.

The range is designed to optimize and rationalize production thanks to its standardized forms and its evolving nature that give to the collection an eco-design approach. The Asymetry collection evolves according to the new needs of the child.

Basé sur la pédagogie Montessori, la collection Asymetry accompagne l'enfant dans sa croissance et le guide dans son apprentissage. L'autonomie, la motricité mais aussi l'imagination de l'enfant sont sans cesse sollicités. La collection Asymetry propose une gamme de produits adaptés aux besoins de l'enfant qui grandiront et évolueront avec lui.

Based on the Montessori pedagogy, the Asymetry collection accompanies the child in his growth and guides him in his learning. The autonomy, the motor skills but also the imagination of the child are constantly soliciting. The Asymetry collection offers a range of products adapted to the needs of the child that will grow and evolve with him.

ASYMETRY

Berceau CODODO - CO-SLEEPING Cradle

MDF + SAPIN + PINE



MADAVIN | COMMODE PIE | MX | ASY COD | ST 140 BB | SO 140 B | CC

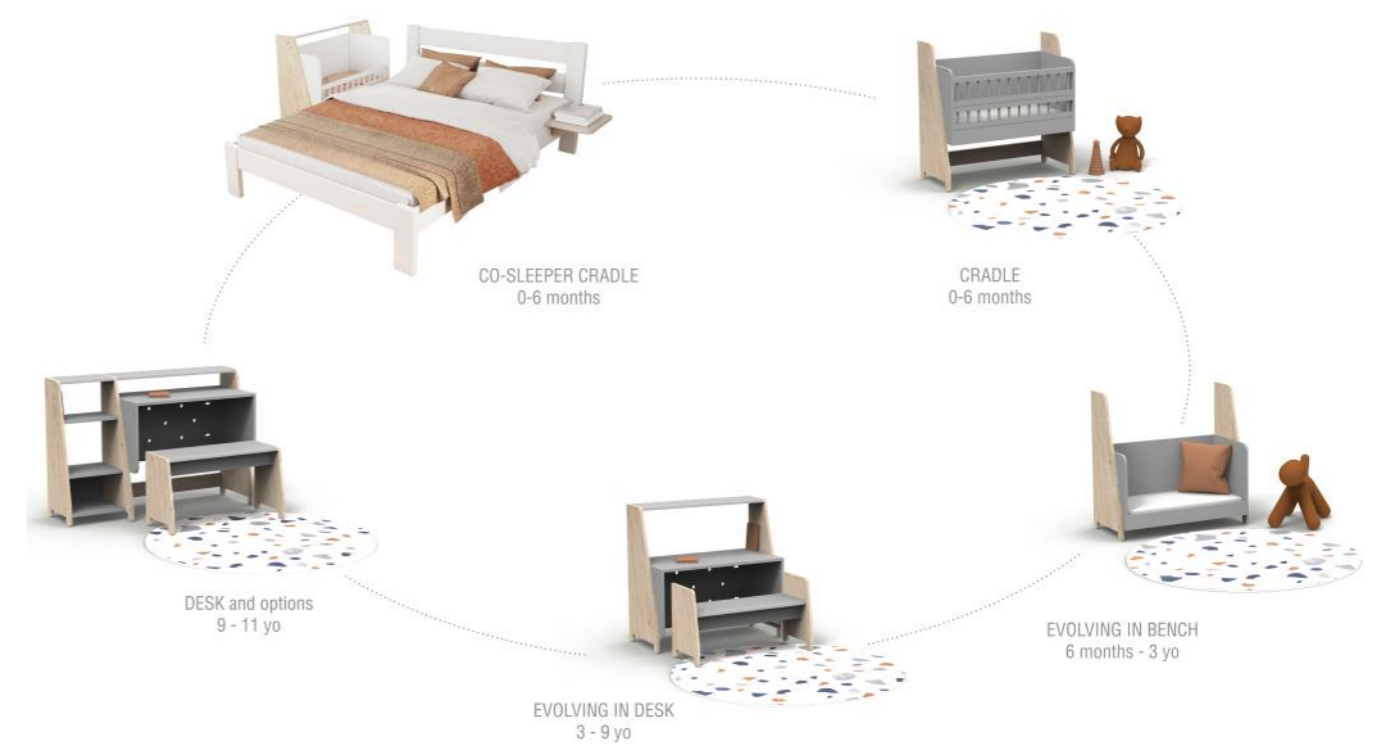

ASY COD L10



ASY COD L20



ASY COD 2 L10

Le Berceau Cododo

Co-Sleeping Cradle

Chez Mathy by Bols, 9 mois après le début du confinement, on pense à vos bambins. Nous avons travaillé pendant plusieurs mois sur un nouveau produit et nous sommes fiers de vous annoncer que notre collection Asymetry s'agrandit !

At Mathy by Bols, 9 months after the start of confinement, we think of your toddlers. We have been working for several months on a new product and we are proud to announce that our Asymetry collection is growing!

Nous vous proposons un berceau cododo évolutif qui vous accompagnera dès la naissance. Un lit cododo s'utilise généralement jusqu'au 6 mois de bébé, mais nous avons étudié notre berceau cododo pour qu'il ait une durée de vie encore plus longue puisqu'il évolue soit en bureau soit en banquette.

We offer you an evolving co-sleeping cradle that will accompany you from birth. A co-sleeping crib is generally used for up to 6 months of baby, but we have designed our co-sleeping crib to have an even longer lifespan since it can be used either in an office or in a bench.

ASYMETRY TOUR D'OBSERVATION - LEARNING TOWER

MDF + SAPIN + PINE



ASY TOUR | ASY B | ASY M

3 HAUTEURS PLATE FORME | 3 HEIGHTS PLATFORM

POSITION 1 : H. 53 CM

POSITION 2 : H. 42 CM

POSITION 3 : H. 31 CM



ÉVOLUTION EN ÉTAGÈRE | EVOLVING IN SHELF



UPGRADE YOUR LEARNING TOWER



ASY TOUR L10 | ASY B



ASY TOUR DS10 | ASY B

La Tour d'observation

La tour d'observation est un indispensables pour développer l'autonomie et les sens de l'enfant. L'enfant est impliqué dans les tâches quotidiennes et notamment dans la préparation du repas.

Très curieux et très demandeur, l'enfant sera ravi d'être à hauteur, de pouvoir voir, sentir, toucher, goûter tous les aliments grâce à sa « tour d'observation » appelée aussi « tour d'apprentissage ». La tour d'observation permet à l'enfant d'être à proximité du plan de travail en toute sécurité. En effet, deux barres de sécurité sur le haut permettent de sécuriser l'espace.

L'enfant peut facilement accéder et grimper dans la tour grâce à une marche à sa hauteur. La tour d'observation s'adapte à l'âge de l'enfant grâce à sa plateforme réglable en 3 hauteurs. Par la suite, la tour évolue en étagère et peut se combiner avec d'autres produits de la collection.

The Learning tower

The learning tower is an essential for developing children's autonomy and senses. The child is involved in daily tasks and in particular in the preparation of the meal.

Very curious and very demanding, the child will be delighted to be up to it, to be able to see, smell, touch and taste all the foods thanks to his learning tower. The tower allows the child to be near the worktop in complete safety. Indeed, two security bars on the top help to secure the space.

Children can easily access and climb the tower thanks to a step at their height. The learning tower is adapted to the age of the child thanks to its adjustable platform in 3 heights. The tower then evolves into a shelf and can be combined with other products from the collection.



CABANE - TREEHOUSE

BY FRANÇOIS LAMAZEROLLES



CABANE - TREEHOUSE

MDF + SAPIN + PINE

AUSSI EN LARGEUR 120 POUR CABANE MONTESSORI | ALSO WIDTH 120 FOR MONTESSORI TREEHOUSE BED
 LARGEUR 120 & 140CM POUR CABANE SIMPLE & SUPERPOSÉE | WIDTH 120 & 140CM FOR SINGLE & BUNK BED

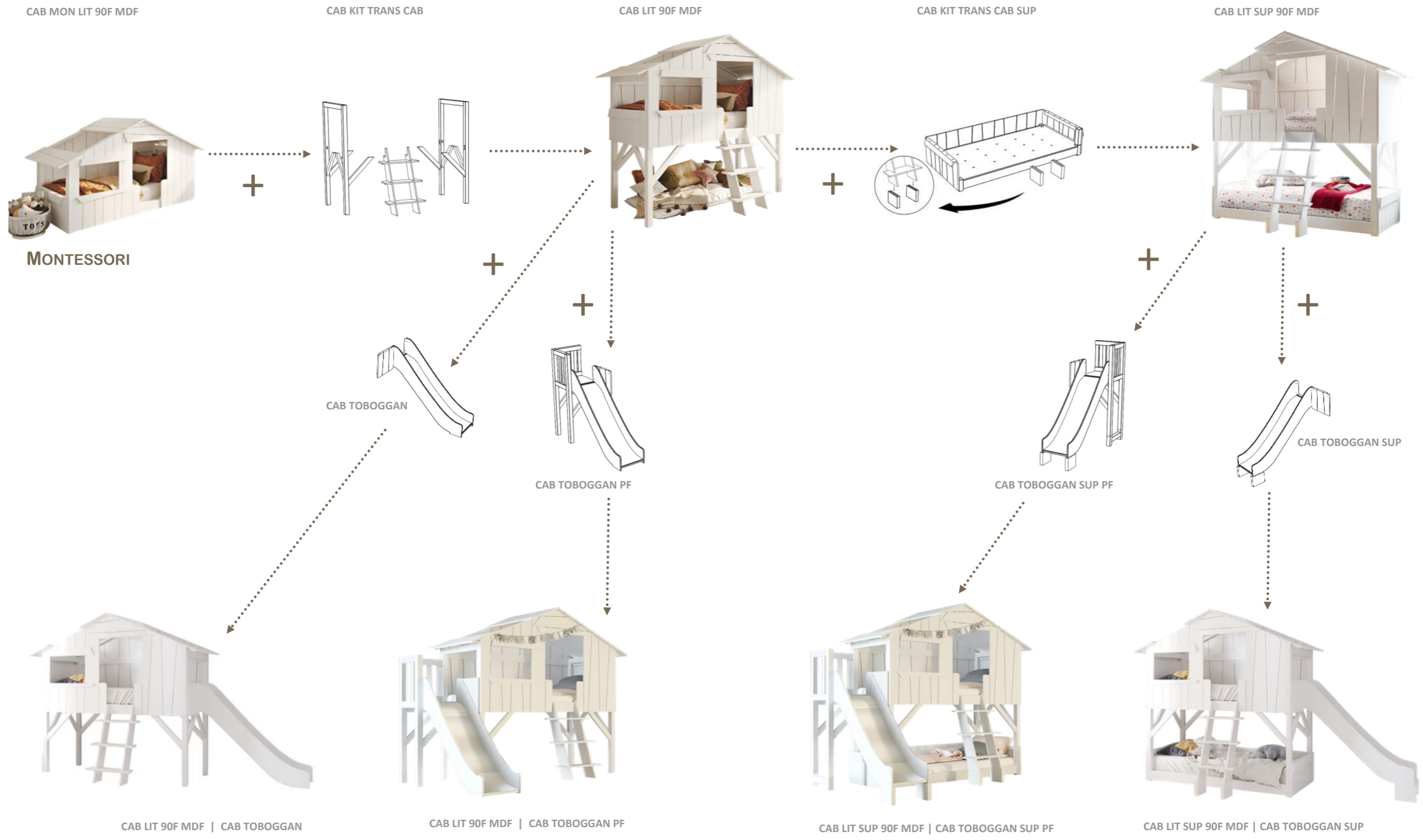

CABANE - TREEHOUSE SUR MESURE - CUSTOM MADE



CABANE STAR - TREEHOUSE

MDF + SAPIN + PINE

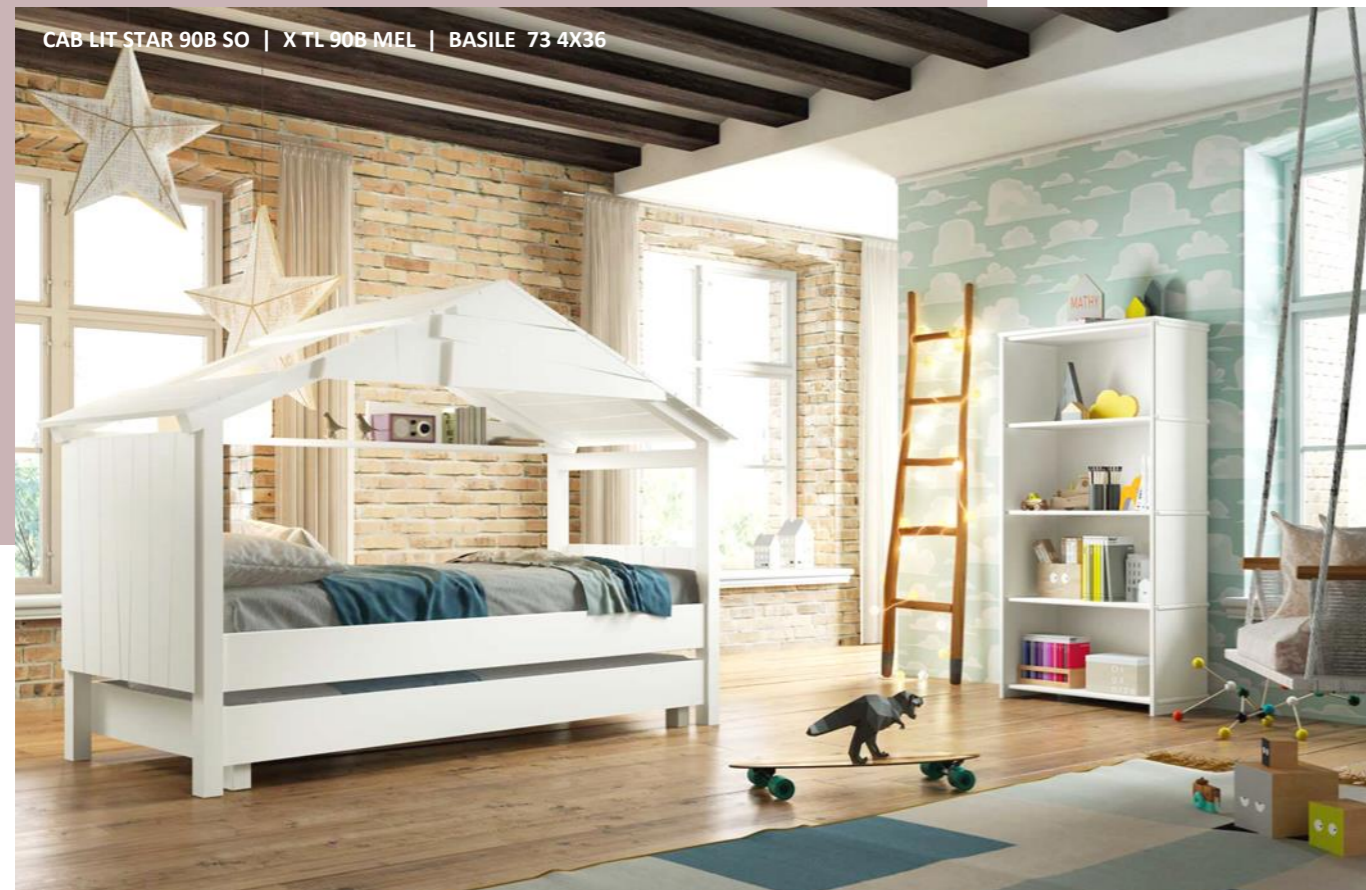

CAB LIT STAR 90B SO | X TL 90B MEL | BASILE 73 4X36

BY FRANÇOIS LAMAZEROLLES

Disponible en largeur 120 & 140cm. Le tiroir = toujours 90cm
 Available in width 120 & 140cm. The drawer = always 90cm



CAB LIT STAR 90B SO



CAB LIT STAR 90B SO | X TL 90B MEL

CARAVANE - CARAVAN

MDF



CAR LIT 90F | CAR SOCLE | CAR TIM COF

©Ormiston House

BY FRANÇOIS LAMAZEROLLES



©Ormiston House

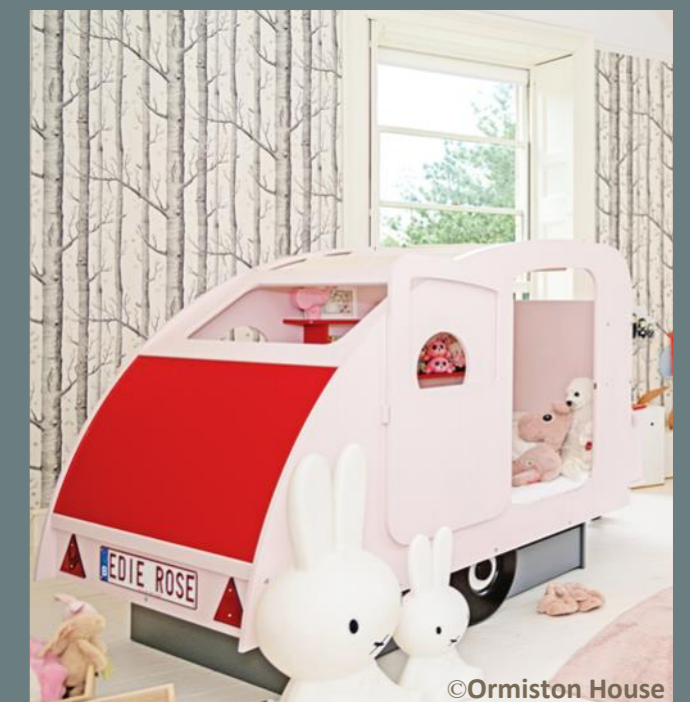

©Ormiston House

TENTE - TENT

BY FRANÇOIS LAMAZEROLLES



MONTESSORI

TENT MON LIT 90 | VI 90 BB | SO 90B



TENT LIT 90B | PA 90 BB | SO 90B | TL 90B MEL



TENT LIT 90B | PA 90 BB | SO 90B

©aventuremaisondeco

MONTESSORI

MDF + SAPIN + PINE



TENT MON LIT 90B | VI 90 BB | SO 90B

Lit | Bed Virginie : Dominique collection

Disponible en largeur 120 & 140cm. Le tiroir = toujours 90cm
Available in width 120 & 140cm. The drawer = always 90cm

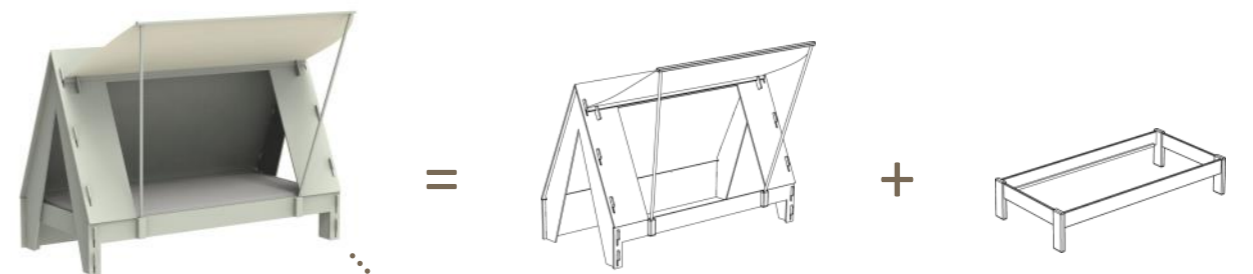

TENT LIT 90B | PA 90 BB | SO 90B

Lit | Bed Paul : Dominique collection

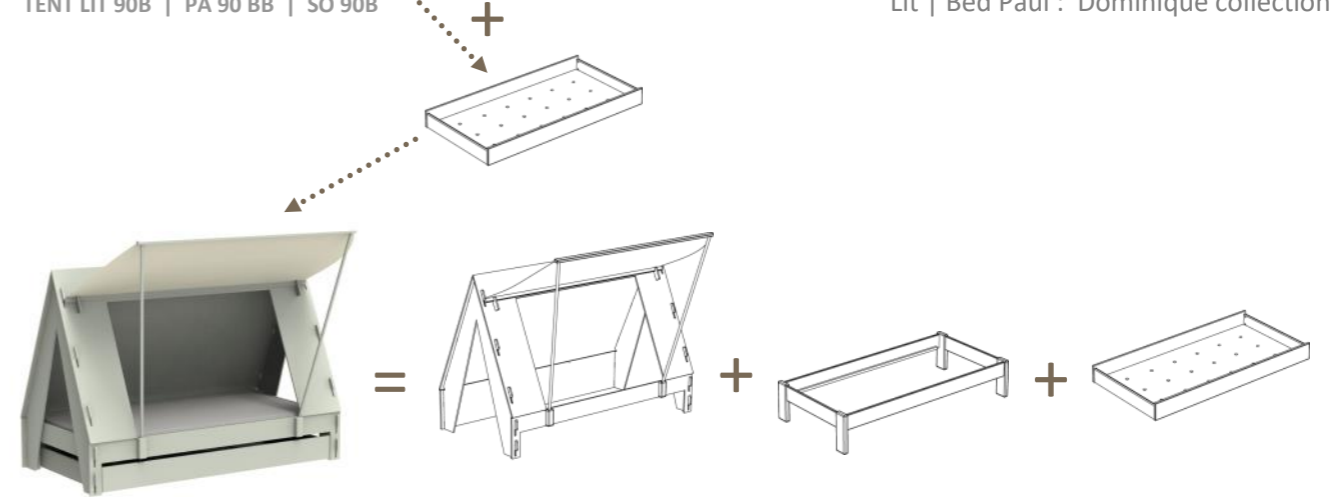

TENT LIT 90B | PA 90 BB | SO 90B | TL 90B MEL

Lit | Bed Paul : Dominique collection

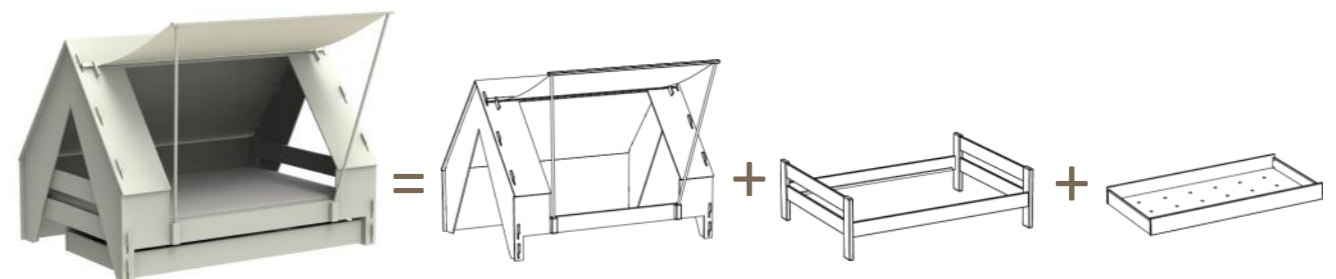

TENT LIT 140B | CL 140 BB | SO 140B | TL 90B MEL

Lit | Bed Claude : Dominique collection

ROULOTTE - CARRIAGE

BY FRANÇOIS LAMAZEROLLES

ROU BASE 120F | ROU SOCLE | ARB BIBLIÔ LOUANE



MDF

ROU LIT 120F | ROU SOCLE



@Rachel Licata

WAGON

WAG LIT SUP 90F | WAG SOCLE | WAG ETAGERE | WAG BUREAU | MADAVIN TABOURET | MADAKET ARM 3P



MDF



MADAVIN

BY ALBANE DE SIGNY-CROMBACK

MDF + BOULEAU + BIRCH



MADAVIN LIT BB | PIE MX | ARM 2P PIE MX | COMMODE PIE MX | PLAN LANGER

LAQUÉ 1 COULEUR OU LAQUÉ + PIEDS MULTIPLEX BOULEAU VERNI
LACQUERED 1 COLOR OR LACQUERED + FEET VARNISH BIRCH PLYWOOD



MADAVIN ARM 3P PIE MX | BUREAU PIE MX | CHEVET PIE MX | LIT 90B SO PIE MX | FUS TABOURET



MADAVIN LIT BB



MADAVIN COMMODE



MADAVIN PLAN LANGER

LIT DISPONIBLE EN LARGEUR 90, 120, 140 & 160CM.
BED AVAILABLE IN WIDTH 90, 120, 140 & 160CM



MACAVIN CHEVET | MADAVIN LIT 120B SO



MADAVIN BUREAU | MADAVIN TABOURET



MADAVIN ARM 1P

L. < 36—65cm >



MADAVIN ARM 2P

L. < 66—124cm >



MADAVIN ARM 3P

L. < 96—183cm >

P. / W. < 40—60cm > H. < 120—240cm >



AUSSI SUR MESURE - ALSO CUSTOM MADE

MADAKET

BY ALBANE DE SIGNY-CROMBACK

MDF



MADAKET CHEVET | LIT 90B SO | TL 90 B | ARM 3P | COMMODE

LIT DISPONIBLE EN LARGEUR 120, 140 & 160CM.
BED AVAILABLE IN WIDTH 120, 140 & 160CM



MADAKET LIT 90B SO | TL 90 B | CHEVET | COFFRE | BIBLIO | BUREAU

UPGRADE YOUR DESK

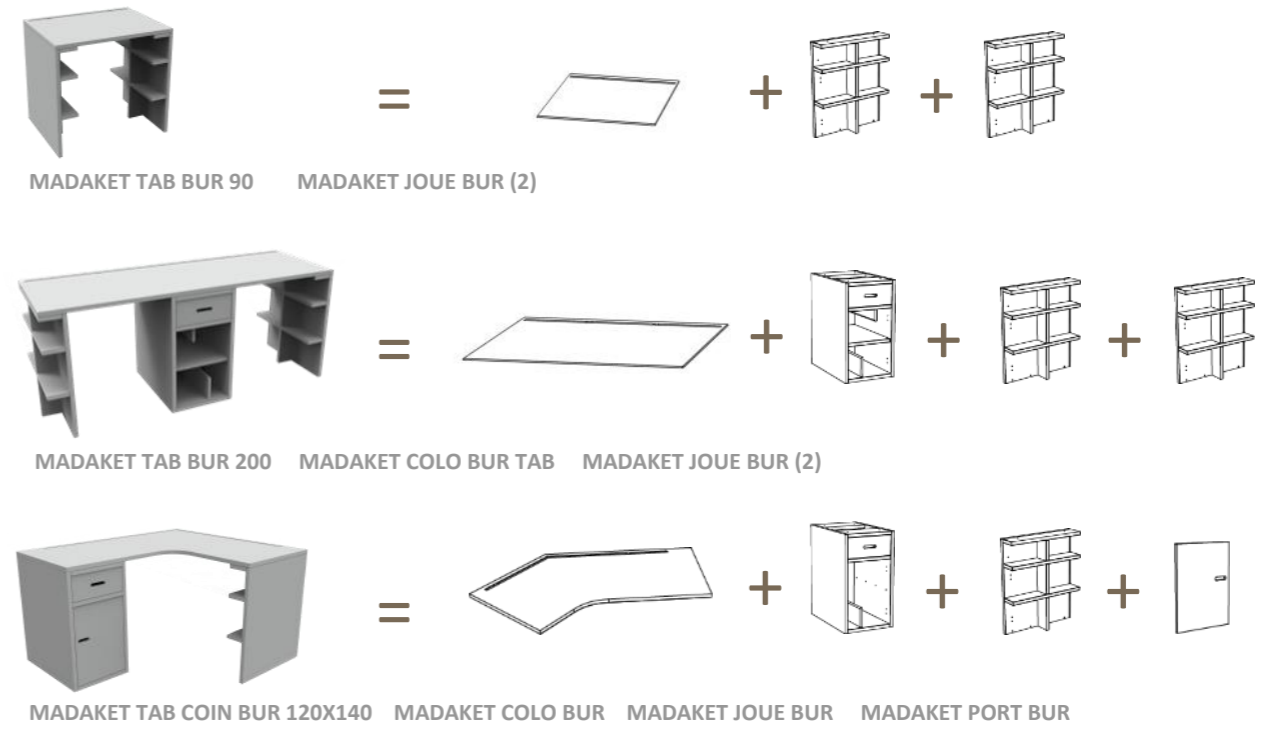

MADAKET ARM 1P

L. < 36—65cm >



MADAKET ARM 2P

L. < 66—124cm >

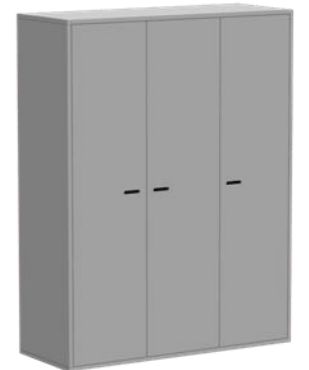

MADAKET ARM 3P

L. < 96—183cm >

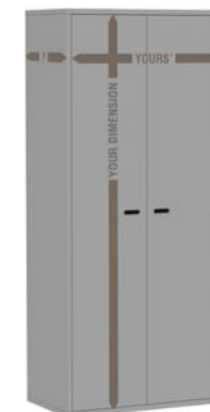

P. / W. < 40—60cm > H. < 120—240cm >

AUSSI SUR MESURE - ALSO CUSTOM MADE

DOMINIQUE

166 90 D BB | SO 90 B | PPPT | CC | TL 90 B | MADAKET BUREAU



CL 90 BB | SO 90 B | ASY DS10 | ASY B1



PA 140 BB | SO 140 B



SUR 172 90 I BB | SO 90 B | TAB BUR SUR B | BASILE



SUR 127 90 I BF | SO 90 F | BUR G SUR 127 90 BF | MADAVIN ARM 2P



SUR 186 90 D BB | SO 90 B | BIBLIO SUR 186 | JEU PORTES INF BIBLIO SUR | MADAKET ARM 3P | TAB BUR SM | JOUE BUR | FUS TABOURET | BASILE



SUR 127 90 I BF | SO 90 F | BUR G SUR 127 90 BF | CAISSON 5T SUR 127 90 BF



196 90 I BB | SO 90 F | PPPT | CC



DOMINIQUE

SAPIN - PINE



BBS



BBS | LON 1200 PAIRE



BBS | PAIRE BASCULE BB SAP



BBS | KIT ROULETTE BB
| TRK BEBE

LARGEUR 80, 90, 120, 140,160 & 180CM (SAUF VIRGINIE) - SUR-MESURE POSSIBLE
WIDTH 80, 90, 120, 140,160 & 180CM (EXCLUDING VIRGINIE) - CUSTOMIZED POSSIBLE

MONTESSORI



VI 90 BB | SO 90B



PA 90 BB | SO 90B



JO 90 BB | SO 90B



ST 90 BB | SO 90B



CL 120 BB | SO 120B



MA 160 BB | SO 80B (2)



BANQ HAUT 90 BF | SO 90F



CAISSON 3P BANQ HAUT 90BF



TL 90 B



TRK 90 B MEL



TL GIG 80 B



166 90 D BB | SO 90B | TL 90 B



149 90 I BB | SO 90B | TRK 90 B MEL



MA 90 BB | SO 90B | TL GIG 80B FER

LARGEUR 80, 90 & 120CM - SUR-MESURE POSSIBLE
WIDTH 80, 90 & 120CM - CUSTOMIZED POSSIBLE



149 90 I BB | SO 90B
INDISSOCIABLE | INSEPARABLE



149 90 D BB | SO 90B
DISSOCIABLE | SEPARABLE



149 D dissocié | dissociated



166 90 I BB | SO 90B
INDISSOCIABLE | INSEPARABLE



166 90 D BB | SO 90B
DISSOCIABLE | SEPARABLE



166 D dissocié | dissociated



166 G 90-140 I BB | SO 90B | SO 140B
INDISSOCIABLE | INSEPARABLE



196 90 I BB | SO 90B
INDISSOCIABLE | INSEPARABLE



166 90 I BB | SO 90 | CC
| ARB BIBLIO JULES 90-50



166 90 D BB | SO 90B | TL 90 B
| RJ 1000 1PC | BUREAU SURELEVE



149 90 D BB | SO 90B | TRK 90 B
| ETAGERE SURELEVE

DOMINIQUE

SUR MESURE - CUSTOM MADE

LARGEUR 80, 90 & 120CM - SUR-MESURE POSSIBLE
WIDTH 80, 90 & 120CM - CUSTOMIZED POSSIBLE



SUR 127 90 I BB | SO 90B
INDISSOCIABLE | INSEPARABLE



SUR 127 90 I BF | SO 90F | BUR D SUR
127 90BF | CAISSON 5T SUR 127 90BF



SUR 127 90 I BF | SO 90F | BUR G SUR
127 90BF | CAISSON 3P SUR 127 90BF



SUR 172 90 I BB | SO 90B
INDISSOCIABLE | INSEPARABLE



SUR 172 90 I BB | SO 90B |
BIBLIO SUR 172



SUR 172 90 I BB | SO 90B | BASILE |
MADAKET TAB BUR 160 | JOUE



SUR 186 90 D BB | SO 90B
DISSOCIABLE | SEPARABLE



SUR 186 90 D BB | BIBLIO SUR186 | JEU
POR BIBLIO (3) | MADAKET TAB BUR 180 |
COLO BUR | PORT BUR



SUR 186 90 D BB | SO 90B | TAB
BUR SUR B | PPPT | CC | ARB BIBLIO
JULES 90



SUR 209 90 D BB | SO 90B
DISSOCIABLE | SEPARABLE



SUR 209 90 D BB | SO 90 B | ST 90 BB | RJ
1000 1PC | BUREAU SURELEVE | FUSION
TABOURET



SUR 209 90 D BB | SO 90B | BUREAU COIN
SURELEVE 90 | ALLONGE BUR COIN B |
ETAGERE SURELEVE | MADAVIN TABOURET

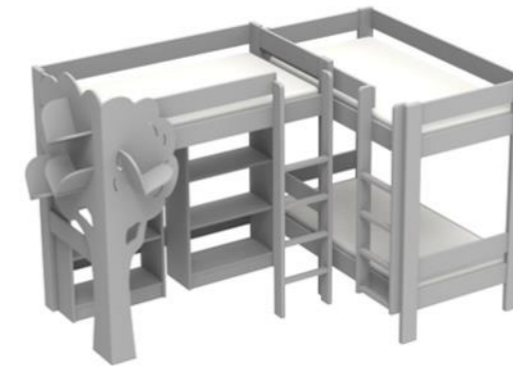

FUSION

BY DAVID ENTHOVEN



FUS LIT BB BC | COMMODE BC | ARM 2P BC



FUS SUR 162 90B SO BC | LIT ENFANT 90B SO BC | COMMODE BC | BUREAU BC | TABOURET | BT | ARM 2P BC

BOULEAU + BIRCH



FUS LIT BB ANO



FUS COMMODE ANO

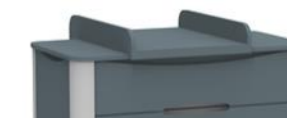

FUS PLAN LANGER



FUS TABOURET | FUS LIT ENFANT 90B SO ANO



FUS BUREAU ANO | FUS BT | FUS TABOURET



FUS SUP 162 90 B 2SO ANO | FUS TL 90 B



FUS SUR 162 90B SO ANO



FUS ARM 2P ANO



FUS TL 90 B

ARBRES - TRESS

BY CHRISTOPHE BOULIN

ARB BIBLIO LOUANE | TEN LIT 90B SO | PA 90BB | SO 90B | TL 90B MEL



ARB BIBLIO LOUANE @life_with_the_three_giesis



ARB BIBLIO SAM | TENT LIT 90B | TL 90B MEL



ARB BIBLIO JULES 50-90 | WAG LIT SUP 90F | WAG SOCLE | WAG ETAGERE | WAG BUREAU



ARB BIBLIO JULES 50-90 | SUR 172 90 | BB | SO 90B | BUREAU COIN SURELEVE 90 | ALLONGE BUR COIN B



ARB BIBLIO TESS



ARB BIBLIO LOUANE

BASILE

MDF



BAS 53-53 2X26 1X36 - BAS PORTE 53 X36

BY DAVID ENTHOVEN

BAS 73-93 4X26 3X26 | BAS PORTE 73-93 X36



SUR 172 | 80 X 180
 BASILE 73-93 1X36 3X26 | BASILE PORTE 73-93 X 36
 MADAKET TAB BUR 130 | MADAKET JOUE



VESSEL

MDF / CHÊNE - OAK / HÊTRE - BEECH



VES GRD BUREAU | VES GRD BANC | VES CHEMINEE

BY ALAIN GILLES

VES SIMPLE BRUT



VES CHEMINEE ROUGE—RED



VES CHATEAU BLEU—BLUE



VES GRD BUREAU | VES GRD BANC
 | VES CHATEAU



VES GRD BUREAU H | VES GRD BANC H
 | VES CHATEAU



MATHY BY BOLS | COULEURS - COLORS

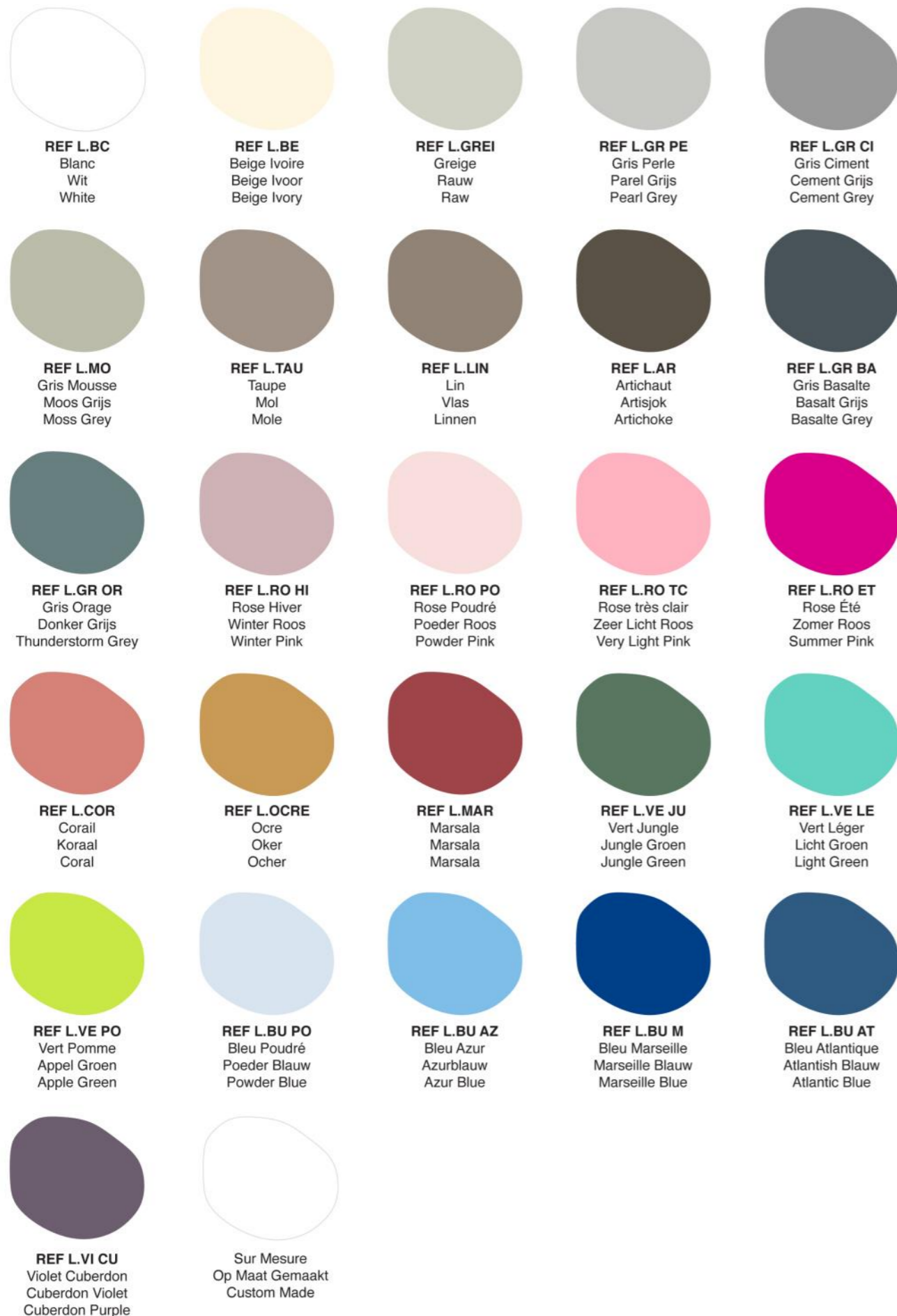

Collection STABLE | STABBLE collectie | STABBLE collection Porte 3D | 3D Deuren | 3D Doors



SAPIN | GRENEN | PINE



VESSEL Collection : Chêne | Eik | Oak



VESSEL Accessoires | Accessories

FINITIONS A L'EAU : 26 COLORIS DIFFÉRENTS.
FINITIONS BICOLORES STANDARDISÉES: + 5 %.
COULEURS SUR DEMANDE RAL OU NCS: + 10 % ET MINIMUM 50€ PAR COULEUR.

Nos finitions, bois et peintures sont aux Normes : EN 71-3V, CPS Act 2008, Sec 101 (USA), CNS 4797-2 (TN), GB6675.4:2014 (CN).
Finitions artisanales et non industrielles. Le zéro défaut n'existe pas sur le bois.
Nœuds, creux et micro fissures apparents; même par la suite.
Le rendu varie avec la direction de la lumière et ne sera jamais 100% identique à celui d'une grande surface, comme sur un meuble entier.
D'une application à l'autre, certaines variations peuvent être constatées.

WATER BASED PAINTING : 26 COLORS AVAILABLE.
TWO-TONE FINISHES STANDARDISED : + 5 %.
COLORS ON REQUEST: RAL OR NCS : + 10 % AND MINIMUM 50 € PER COLOR.

Our finishes, wood and painting comply with EN 71-3V, CPS Act 2008, Sec 101 (USA), CNS 4797-2 (TN), GB6675.4:2014 (CN).
Craft production and not industrial. Knots, small cracks, ..etc, will be visible or may reappear over time.
The color rendering vary with the direction of light. It will never be 100% identical to that of a large area as an entire furniture.
One application to another, some variations can be observed.

MATHY BY BOLS S.A. Chaussée de Roly 26, 5660 MARIEMBOURG, BELGIUM
 info@mathy-by-bols.be - TEL.+32 (0)60 31.30.30 - FAX. +32 (0)60 31.30.29
www.mathy-by-bols.be

